

PARTIAL REPRESENTATION OF AVAILABLE CHECK VALVES

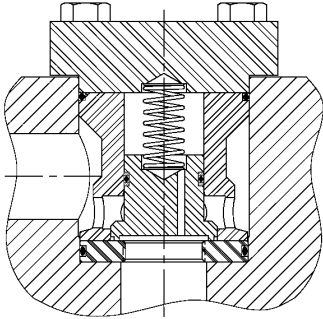

Check Valve Pocket Mount

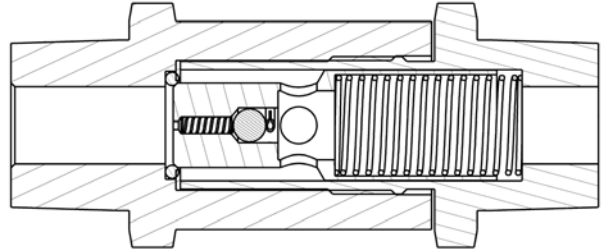

Check Valve w/Excess Flow/Bleed

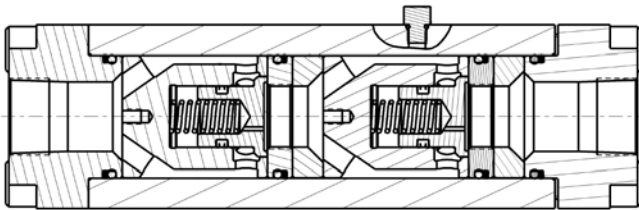

Double Check Valve - In-Line

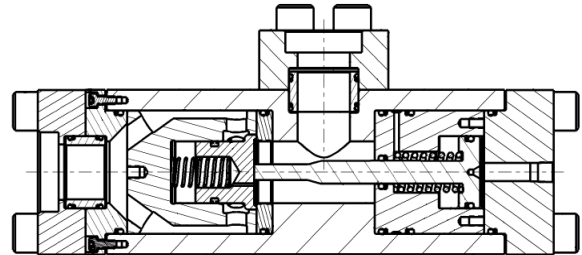

POCV, Socket Weld Ports

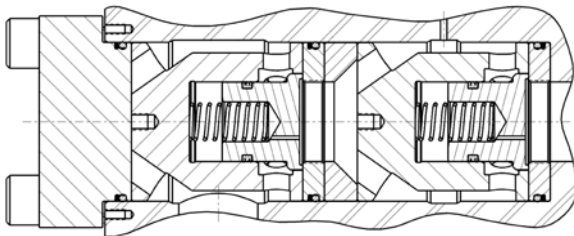

Double Check Valve - Pocket Mount

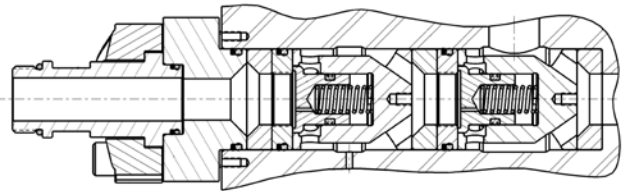

Double Check Valve - SAE Male - Pocket

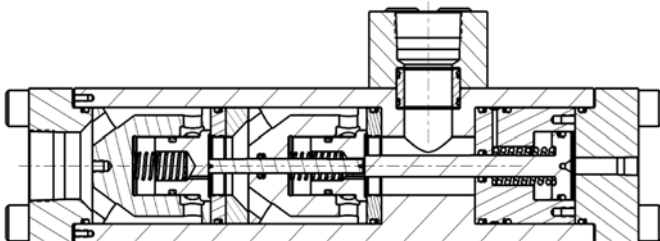

Double POCV, NPT Ports

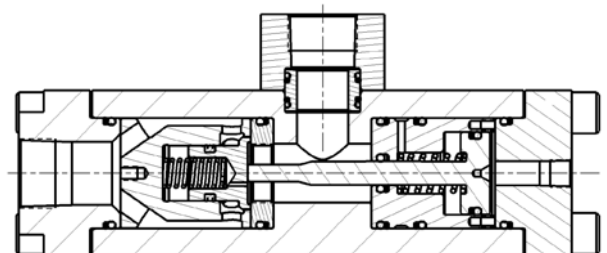

POCV, NPT Ports



CHECK VALVE SPECIFICATIONS

Check Valve Size	1/2"	1"	1-1/2"
Pressure Rating	5K PSI	5K PSI	5K PSI
Typical Flow (@ 500 PSI Δ P)	75 GPM	370 GPM	825 GPM
Flow Area	0.16 IN²	0.78 IN²	1.77 IN²
Equivalent Hole Dia.	0.45"	1.00"	1.50"
Cv	3.3	17	37
Pilot Ratio	1:2	1:3	1:3
Cracking Pressure	30 PSI	30 PSI	30 PSI
Cv (Double Check)	—	12	26
Typical Flow (Double Check) (@ 500 PSI Δ P)	—	270 GPM	580 GPM

CHECK VALVES CHECK VALVES CHECK VALVES CHECK VALVES

